

Wedge-Bolt+ *Screw Anchor*

PRODUCT DESCRIPTION

The Wedge-Bolt+ anchor is a one piece, heavy duty screw anchor with a finished hex head. It is simple to install, easy to identify and fully removable. The Wedge-Bolt+ has features and benefits that make it well suited for many applications. The steel threads along the anchor body tap into the hole during installation to provide keyed engagement. Suitable base materials include normal-weight concrete, structural sand-lightweight concrete, concrete over steel deck, concrete masonry and solid clay brick.

GENERAL APPLICATIONS AND USES

- Racking, shelving and material handling
- Support ledgers and temporary attachments
- Interior applications/low level corrosion environment
- Retrofits, repairs and maintenance
- Fencing and railing
- Seismic and wind loading

FEATURES AND BENEFITS

- + Consistent performance in high and low strength concrete
- + Anchor can be installed through standard fixture holes
- + Wedge-bit size is matched to the nominal anchor diameter
- + Diameter, length and identifying marking stamped on head of each anchor
- + Fast installation with a powered impact wrench
- + One-piece, finished head design eliminates improper assembly or missing components

APPROVALS AND LISTINGS

International Code Council, Evaluation Service (ICC-ES), ESR-2526 for concrete.
 International Code Council, Evaluation Service (ICC-ES), ESR-1678 for concrete masonry
 Code compliant with the 2012 IBC, 2012 IRC, 2009 IBC, 2009 IRC, 2006 IBC, 2006 IRC, 2003 IBC, 2003 IRC
 Tested in accordance with ACI 355.2 and ICC-ES AC193 for use in structural applications in concrete under the design provisions of ACI 318 (Strength Design method using Appendix D)
 Evaluated and qualified by an accredited independent testing laboratory for recognition in cracked and uncracked concrete including seismic and wind loading (Category 1 anchors)
 Evaluated and qualified by an accredited independent testing laboratory for reliability against brittle failure, e.g. hydrogen embrittlement
 Tested in accordance with ASTM E488 and AC106 criteria

GUIDE SPECIFICATIONS

CSI Divisions: 03 16 00 - Concrete Anchors, 04 05 19.16 - Masonry Anchors and 05 05 19 - Post-Installed Concrete Anchors. Screw anchors shall be Wedge-Bolt+ as supplied by Powers Fasteners, Inc., Brewster, NY. Anchors shall be installed in accordance with published instructions and the Authority Having Jurisdiction.

MATERIAL SPECIFICATIONS

Anchor component	Specification
Anchor Body and hex washer head	Case hardened low carbon steel
Plating	Zinc plating according to ASTM B 633, SC1 Type III (Fe/Zn 5). Minimum plating requirements for Mild Service Condition.
	Mechanically Galvanized Zinc plating according to ASTM B 695, Class 55

SECTION CONTENTS Page No.

General Information..... 1

Material Specifications 1

Installation Specifications..... 2

Installation Instructions 3

SD Factored Design Strength..... 4

ASD Performance Data..... 6

Masonry Performance Data 9

Design Criteria 11

SD Performance Data..... 14

Ordering Information 16



Wedge-Bolt+

ANCHOR MATERIALS

Zinc plated carbon steel body and hex washer head or mechanically galvanized carbon steel body and hex washer head

ANCHOR SIZE RANGE (TYP.)

1/4" diameter through 3/4" diameter
(see ordering information)

SUITABLE BASE MATERIALS

Normal-weight concrete
 Structural sand-lightweight concrete
 Concrete over steel deck
 Grouted concrete masonry (CMU)
 Solid clay brick



This Product Available In



Powers Design Assist
 Real Time Anchor Design Software
www.powersdesignassist.com

INSTALLATION SPECIFICATIONS

Installation Table for Wedge-Bolt+ (Design Provisions of ACI 318 Appendix D)

Anchor Property/ Setting Information	Notation	Units	Nominal Anchor Size							
			1/4"	3/8		1/2"		5/8		3/4"
Nominal anchor diameter	d_a	in. (mm)	0.250 (6.4)	0.375 (9.5)		0.500 (12.7)		0.625 (15.9)		0.750 (19.1)
Minimum diameter of hole clearance in fixture	d_h	in. (mm)	5/16 (7.9)	7/16 (11.1)		9/16 (14.3)		11/16 (17.5)		0.750 (19.1)
Nominal drill bit diameter	d_{bit}	in.	1/4 Wedge-bit	3/8 Wedge-bit		1/2 Wedge-bit		5/8 Wedge-bit		3/4 Wedge-bit
Wedge-bit tolerance range	-	in.	0.255 to 0.259	0.385 to 0.389		0.490 to 0.495		0.600 to 0.605		0.720 to 0.725
Minimum nominal embedment depth	h_{nom}	in. (mm)	1-3/4 (44)	2-1/8 (54)		2-1/2 (64)	3-1/2 (89)	3-1/4 (83)	4-3/8 (111)	4-1/4 (108)
Effective embedment	h_{ef}	in. (mm)	1.100 (28)	1.425 (36)		1.650 (42)	2.500 (64)	2.145 (55)	3.100 (79)	2.910 (74)
Minimum concrete member thickness ¹	h_{min}	in. (mm)	3-1/4 (83)	3-1/2 (89)	4 (102)	4 (102)	6 (152)	6 (152)	7 (178)	7 (178)
Critical edge distance ¹	c_{ac}	in. (mm)	2-1/2 (64)	4 (102)	2-3/4 (70)	4 (102)	4-1/2 (114)	5 (127)	5 (127)	6 (152)
Minimum edge distance ¹	c_{min}	in. (mm)	1-1/2 (38)	1-1/2 (38)	1-3/4 (44)	1-3/4 (44)	1-3/4 (44)	1-3/4 (44)	1-3/4 (44)	1-3/4 (44)
Minimum spacing distance ¹	s_{min}	in. (mm)	2 (51)	2-1/2 (64)	2-1/2 (64)	3-1/2 (89)	2-1/2 (64)	3-3/4 (95)	3 (76)	4-1/2 (114)
Minimum hole depth ¹	h_o	in. (mm)	2 (51)	2-1/4 (57)		3 (76)	4 (102)	4 (102)	5 (127)	5 (127)
Minimum overall anchor length	l_{anch}	in. (mm)	2-1/4 (57)	2-1/2 (64)		3 (76)	4 (102)	4 (102)	5 (127)	5 (127)
Maximum impact wrench power (torque)	T_{screw}	ft.-lb. (N-m)	115 (156)	245 (332)		300 (407)		350 (475)		400 (542)
Impact wrench socket size	-	in.	7/16	9/16		3/4		15/16		1-1/8
Head height	-	in.	7/32	21/64		7/16		1/2		19/32

1. For installations through the soffit of steel deck into concrete, see the installation detail. Anchors in the lower flute may be installed with a maximum 1-inch offset in either direction from center of the flute. In addition, anchors shall have an axial spacing along the flute equal to the greater of $3h_{ef}$ or 1.5 times the flute width.

Wedge-Bolt+ Anchor Detail

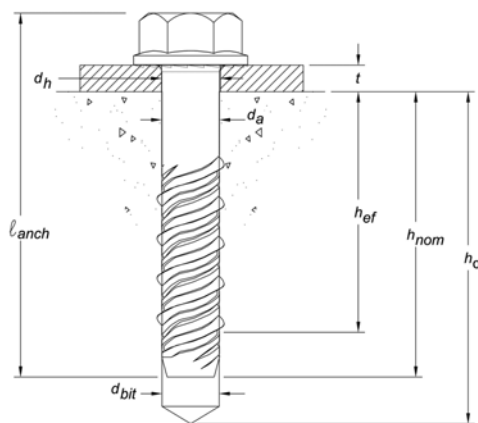

Hex Head Marking



Legend

Diameter and Length Identification Mark

'+' Symbol = Strength Design Compliant Anchor
(see ordering information)

Matched Tolerance System

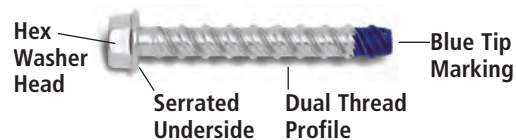

Designed and tested as a system for consistency and reliability

INSTALLATION SPECIFICATIONS

Installation Instructions for Wedge-Bolt+

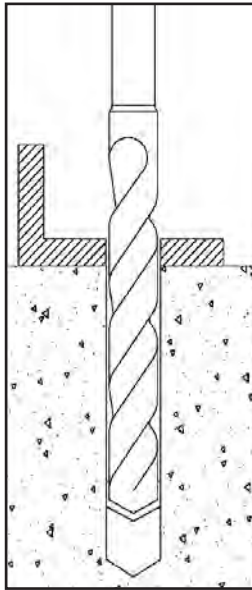

1.) Using the proper Wedge-Bit size, drill a hole into the base material to the required depth. The tolerances of the carbide Wedge-Bit used must meet the requirements of the published Wedge-Bit range.

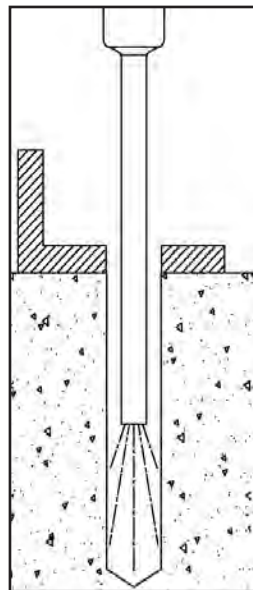

2.) Remove dust and debris from the hole.

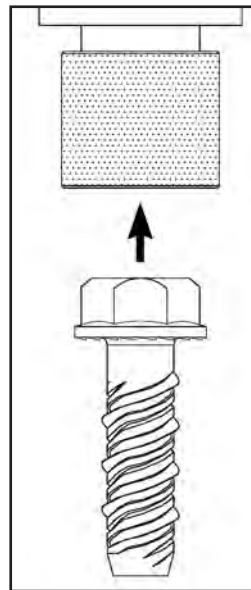

3.) Select a powered impact wrench that does not exceed the maximum torque, T_{screw} for the selected anchor diameter. Attach an appropriate sized hex socket to the impact wrench. Mount the screw anchor head into the socket.

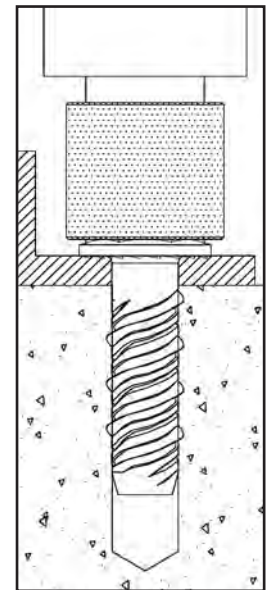

4.) Drive the anchor through the fixture and into the hole until the head of the anchor comes into contact with the fixture. The anchor should be snug after installation. Do not spin the hex socket off the anchor to disengage.

Installation Detail for Wedge-Bolt+ Installed into Topside of Steel Deck Assemblies

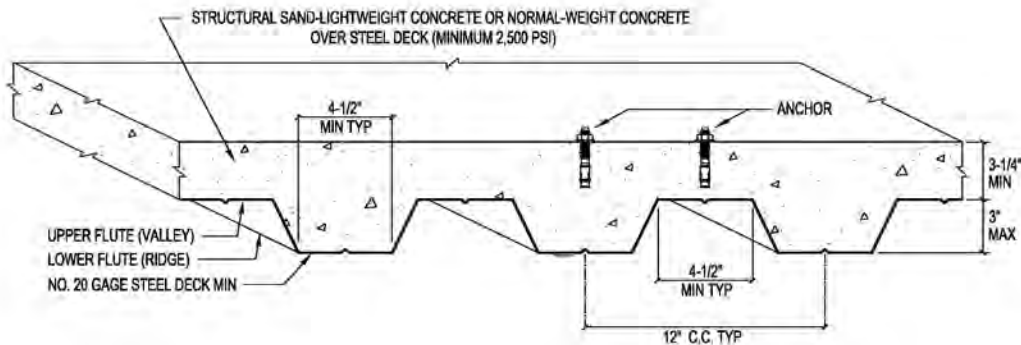

Installation Detail for Wedge-Bolt+ Installed Through Soffit of Steel Deck into Concrete

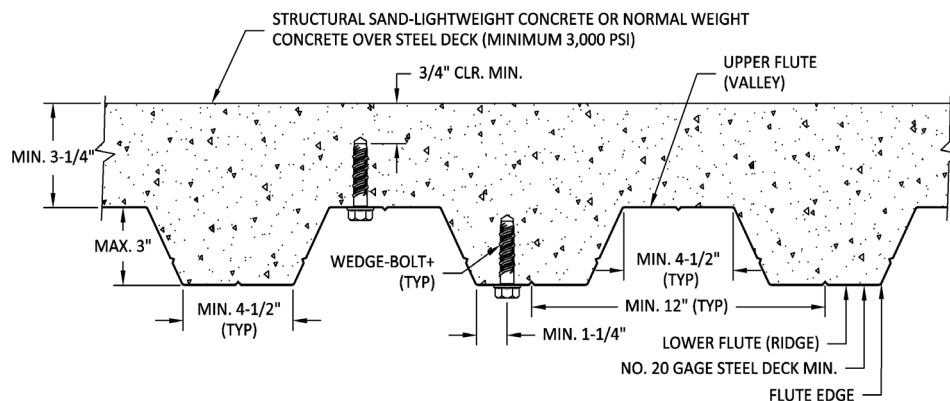

FACTORED RESISTANCE STRENGTH (ϕN_u AND ϕV_u) CALCULATED IN ACCORDANCE WITH APPENDIX D:

- Tabular values are provided for illustration and are applicable for single anchors installed in normal-weight concrete with minimum slab thickness, $h_s = h_{min}$, and with the following conditions:
 - c_{a1} is greater than or equal to the critical edge distance, c_{ac} (table values based on $c_{a1} = c_{ac}$).
 - c_{a2} is greater than or equal to 1.5 times c_{a1} .
- Calculations were performed according to ACI 318-05 Appendix D. The load level corresponding to the controlling failure mode is listed. (e.g. For tension: steel, concrete breakout and pullout; For shear: steel, concrete breakout and pryout). Furthermore, the capacities for concrete breakout strength in tension and pryout strength in shear are calculated using the effective embedment values, h_{ef} , for the selected anchors as noted in the design information tables. Please also reference the installation specifications for more information.
- Strength reduction factors (ϕ) were based on ACI 318 Section 9.2 for load combinations. Condition B is assumed.
- Tabular values are permitted for static loads only, seismic loading is not permitted with these tables.
- For designs that include combined tension and shear, the interaction of tension and shear loads must be calculated in accordance with ACI 318 Appendix D.
- Interpolation is not permitted to be used with the tabular values. For intermediate base material compressive strengths please see ACI 318 Appendix D. For other design conditions including seismic considerations please see ACI 318 Appendix D.

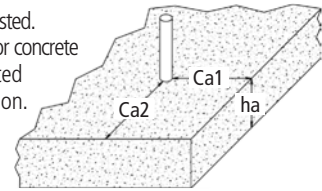

Tension and Shear Factored Resistance Strength for Wedge-Bolt+ in Cracked Concrete

Nominal Anchor Size (in.)	Nominal Embed. h_{nom} (in.)	Minimum Concrete Compressive Strength, $f'c$ (psi)									
		2,500		3,000		4,000		6,000		8,000	
		ϕN_n Tension (lbs.)	ϕV_n Shear (lbs.)	ϕN_n Tension (lbs.)	ϕV_n Shear (lbs.)	ϕN_n Tension (lbs.)	ϕV_n Shear (lbs.)	ϕN_n Tension (lbs.)	ϕV_n Shear (lbs.)	ϕN_n Tension (lbs.)	ϕV_n Shear (lbs.)
1/4	1-3/4	-	-	-	-	-	-	-	-	-	-
3/8	2-1/8	940	940	1,030	1,030	1,190	1,190	1,460	1,460	1,685	1,685
1/2	2-1/2	1,175	1,145	1,285	1,250	1,485	1,445	1,815	1,770	2,100	2,045
	3-1/2	1,925	1,915	2,110	2,095	2,440	2,420	2,985	2,965	3,450	3,420
5/8	3-1/4	1,735	1,870	1,905	2,050	2,195	2,365	2,690	2,900	3,105	3,345
	4-3/8	2,790	2,785	3,055	3,050	3,525	3,520	4,320	4,325	4,990	4,980
3/4	4-1/4	2,740	3,180	3,005	3,485	3,465	4,025	4,245	4,925	4,905	5,690

Tension and Shear Factored Resistance Strength for Wedge-Bolt+ in Uncracked Concrete

Nominal Anchor Size (in.)	Nominal Embed. h_{nom} (in.)	Minimum Concrete Compressive Strength, $f'c$ (psi)									
		2,500		3,000		4,000		6,000		8,000	
		ϕN_n Tension (lbs.)	ϕV_n Shear (lbs.)	ϕN_n Tension (lbs.)	ϕV_n Shear (lbs.)	ϕN_n Tension (lbs.)	ϕV_n Shear (lbs.)	ϕN_n Tension (lbs.)	ϕV_n Shear (lbs.)	ϕN_n Tension (lbs.)	ϕV_n Shear (lbs.)
1/4	1-3/4	900	970	985	1,060	1,140	1,225	1,395	1,485	1,610	1,485
3/8	2-1/8	1,330	1,320	1,455	1,445	1,680	1,670	2,060	2,045	2,375	2,360
1/2	2-1/2	1,655	1,600	1,815	1,755	2,095	2,025	2,565	2,480	2,965	2,865
	3-1/2	3,085	2,680	3,380	2,935	3,905	3,385	4,780	4,150	5,520	4,780
5/8	3-1/4	2,450	2,680	3,380	2,895	3,100	3,340	3,800	4,090	4,385	4,725
	4-3/8	4,260	3,900	3,380	4,270	5,390	4,930	6,600	6,040	7,625	6,975
3/4	4-1/4	3,870	4,455	4,240	4,880	4,895	5,635	5,995	6,900	6,925	7,965

Legend

- Steel Strength Controls
- Concrete Breakout Strength Controls
- Anchor Pullout/Pryout Strength Controls

FACTORED RESISTANCE STRENGTH (ϕN_u AND ϕV_u) CALCULATED IN ACCORDANCE WITH APPENDIX D:

1. Tabular values are provided for illustration and are applicable for single anchors installed in normal-weight concrete with minimum slab thickness, $h_a = h_{min}$, and with the following conditions:
 - c_{a1} is greater than or equal to the critical edge distance, c_{ac} (table values based on $c_{a1} = c_{ac}$).
 - c_{a2} is greater than or equal to 1.5 times c_{a1} .
2. Calculations were performed according to ACI 318-05 Appendix D. The load level corresponding to the controlling failure mode is listed. (e.g. For tension: steel, concrete breakout and pullout; For shear: steel, concrete breakout and pryout). Furthermore, the capacities for concrete breakout strength in tension and pryout strength in shear are calculated using the effective embedment values, h_{ef} , for the selected anchors as noted in the design information tables. Please also reference the installation specifications for more information.
3. Strength reduction factors (ϕ) were based on ACI 318 Section 9.2 for load combinations. Condition B is assumed.
4. Tabular values are permitted for static loads only, seismic loading is not considered with these tables.
5. For designs that include combined tension and shear, the interaction of tension and shear loads must be calculated in accordance with ACI 318 Appendix D.
6. Interpolation is not permitted to be used with the tabular values. For intermediate base material compressive strengths please see ACI 318 Appendix D. For other design conditions including seismic considerations please see ACI 318 Appendix D.

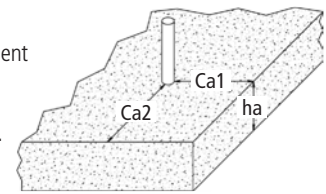

MECHANICAL ANCHORS

Tension and Shear Factored Resistance Strength with 1-3/4" Edge Distance for Wedge-Bolt+ in Cracked Concrete

Nominal Anchor Size (in.)	Nominal Embed. h_{nom} (in.)	Minimum Concrete Compressive Strength, $f'c$ (psi)									
		2,500		3,000		4,000		6,000		8,000	
		ϕN_n Tension (lbs.)	ϕV_n Shear (lbs.)	ϕN_n Tension (lbs.)	ϕV_n Shear (lbs.)	ϕN_n Tension (lbs.)	ϕV_n Shear (lbs.)	ϕN_n Tension (lbs.)	ϕV_n Shear (lbs.)	ϕN_n Tension (lbs.)	ϕV_n Shear (lbs.)
1/4	1-3/4	-	-	-	-	-	-	-	-	-	-
3/8	2-1/8	395	455	435	495	500	575	615	705	710	810
1/2	2-1/2	400	510	440	560	505	645	620	790	715	910
	3-1/2	425	555	465	605	535	700	655	855	760	990
5/8	3-1/4	415	575	450	630	520	725	640	890	740	1025
	4-3/8	445	620	490	675	565	780	690	955	795	1105
3/4	4-1/4	440	645	480	705	555	815	680	1000	785	1150

Tension and Shear Factored Resistance Strength with 1-3/4" Edge Distance for Wedge-Bolt+ in Uncracked Concrete

Nominal Anchor Size (in.)	Nominal Embed. h_{nom} (in.)	Minimum Concrete Compressive Strength, $f'c$ (psi)									
		2,500		3,000		4,000		6,000		8,000	
		ϕN_n Tension (lbs.)	ϕV_n Shear (lbs.)	ϕN_n Tension (lbs.)	ϕV_n Shear (lbs.)	ϕN_n Tension (lbs.)	ϕV_n Shear (lbs.)	ϕN_n Tension (lbs.)	ϕV_n Shear (lbs.)	ϕN_n Tension (lbs.)	ϕV_n Shear (lbs.)
1/4	1-3/4	390	535	425	585	490	675	600	825	695	955
3/8	2-1/8	435	635	475	695	550	805	675	985	780	1,135
1/2	2-1/2	430	715	470	780	545	900	665	1,105	770	1,275
	3-1/2	560	775	545	850	630	980	775	1,200	895	1,385
5/8	3-1/4	500	805	640	880	735	1,015	900	1,245	1,140	1,435
	4-3/8	585	865	640	945	740	1,095	905	1,340	1,145	1,545
3/4	4-1/4	450	900	495	990	570	1,140	695	1,395	805	1,615

Legend

Concrete Breakout Strength Controls

ASD PERFORMANCE DATA
Ultimate Load Capacities for Wedge-Bolt+ Installed into Normal-Weight Concrete at Critical Spacing and Edge Distances^{1,2,3}

Anchor Diameter in. (mm)	Minimum Embedment Depth in. (mm)	Minimum Concrete Compressive Strength (f'c)					
		2,000 psi (13.8 Mpa)		4,000 psi (27.6 Mpa)		6,000 psi (41.4 Mpa)	
		Tension lbs. (kN)	Shear lbs. (kN)	Tension lbs. (kN)	Shear lbs. (kN)	Tension lbs. (kN)	Shear lbs. (kN)
1/4 (6.4)	1 (25.4)	720 (3.2)	920 (4.0)	1,340 (6.0)	1,880 (8.3)	1,660 (7.5)	2,160 (9.6)
	1-1/2 (38.1)	1,440 (6.5)	2,000 (8.8)	2,140 (9.6)	2,080 (9.2)	2,480 (11.2)	2,260 (10.0)
	2 (50.8)	2,400 (10.8)	2,000 (8.8)	3,940 (17.7)	2,080 (9.2)	4,980 (22.4)	2,680 (11.9)
	2-1/2 (63.5)	3,520 (15.8)	2,000 (8.8)	4,660 (21.0)	2,080 (9.2)	5,260 (23.7)	2,680 (11.9)
3/8 (9.5)	1-1/2 (38.1)	1,900 (8.6)	2,760 (12.2)	2,520 (11.3)	3,440 (15.3)	3,040 (13.7)	5,600 (24.9)
	2 (50.8)	3,000 (13.5)	3,100 (13.7)	3,920 (17.6)	3,440 (15.3)	5,200 (23.4)	5,600 (24.9)
	2-1/2 (63.5)	4,100 (18.5)	3,440 (15.3)	5,320 (23.9)	3,440 (15.3)	7,340 (33.0)	5,600 (24.9)
	3 (76.2)	5,800 (26.1)	4,120 (18.3)	7,740 (34.8)	4,320 (19.2)	9,900 (44.6)	5,600 (24.9)
	3-1/2 (88.9)	7,500 (33.8)	4,820 (21.4)	10,140 (45.6)	5,200 (23.1)	12,440 (56.0)	5,600 (24.9)
1/2 (12.7)	2 (50.8)	2,860 (12.9)	4,960 (22.0)	3,940 (17.7)	5,680 (25.2)	4,780 (21.5)	7,600 (33.8)
	2-1/2 (63.5)	4,100 (18.5)	5,800 (25.8)	5,200 (23.4)	6,480 (28.8)	6,480 (28.8)	7,960 (35.4)
	3 (76.2)	5,920 (26.6)	6,200 (27.5)	7,800 (35.1)	7,240 (32.2)	9,380 (42.2)	7,960 (35.4)
	3-1/2 (88.9)	6,060 (27.3)	8,020 (35.6)	8,480 (38.2)	8,160 (36.2)	11,900 (53.6)	8,600 (38.2)
	4 (101.6)	7,560 (34.0)	8,660 (39.0)	12,620 (56.8)	9,080 (40.9)	12,620 (56.8)	9,600 (43.2)
5/8 (15.9)	2-1/2 (63.5)	3,420 (15.4)	7,200 (32.4)	4,720 (21.2)	10,240 (45.5)	6,900 (31.1)	10,180 (45.2)
	3 (76.2)	4,560 (20.5)	7,920 (35.2)	7,380 (33.2)	10,240 (45.5)	8,960 (40.3)	11,400 (50.7)
	3-1/2 (88.9)	5,720 (25.7)	8,640 (38.4)	10,040 (45.2)	10,240 (45.5)	11,040 (49.7)	11,400 (50.7)
	4 (101.6)	8,240 (37.1)	9,540 (42.4)	12,760 (57.4)	11,140 (49.5)	14,320 (64.4)	12,080 (53.7)
	4-1/2 (114.3)	10,780 (48.5)	10,460 (46.5)	15,500 (69.8)	12,040 (53.5)	17,600 (79.2)	12,760 (56.7)
	5 (127.0)	13,300 (59.9)	11,360 (50.5)	18,220 (82.0)	12,960 (57.6)	20,860 (93.9)	13,480 (59.9)
3/4 (19.1)	3 (76.2)	4,320 (19.4)	9,480 (42.1)	6,480 (29.2)	12,120 (53.9)	8,700 (39.2)	14,800 (65.8)
	3-1/2 (88.9)	5,720 (25.7)	10,460 (46.5)	9,320 (41.9)	14,820 (65.9)	11,360 (51.1)	16,400 (72.9)
	4 (101.6)	7,120 (32.0)	11,460 (50.9)	12,140 (54.6)	17,520 (77.9)	14,020 (63.1)	18,000 (80.0)
	4-1/2 (114.3)	9,240 (41.6)	13,120 (58.3)	13,580 (61.1)	18,660 (83.0)	16,720 (75.2)	19,840 (88.2)
	5 (127.0)	11,340 (51.0)	14,780 (65.7)	15,020 (67.6)	19,740 (89.8)	19,400 (87.3)	21,700 (96.5)
	5-1/2 (139.7)	13,440 (60.5)	16,640 (74.0)	16,460 (74.1)	20,840 (92.7)	22,080 (99.4)	23,560 (104.8)
	6 (152.4)	15,540 (69.9)	18,120 (80.6)	17,900 (80.6)	21,960 (97.6)	24,760 (111.4)	25,420 (113.0)

1. Tabulated load values are for anchors installed in concrete. Concrete compressive strength must be at the specified minimum at the time of installation.

2. Ultimate load capacities must be reduced by a minimum safety factor of 4.0 or greater to determine allowable working load.

3. Allowable load capacities are multiplied by reduction factors found in the Design Criteria section when anchor spacing or edge distances are less than critical distances.

ASD PERFORMANCE DATA

Ultimate and Allowable Load Capacities for Wedge-Bolt+ Installed into Structural Lightweight Concrete^{1,2,3,4}

Nominal Anchor Diameter d in. (mm)	Minimum Embedment Depth h _v in. (mm)	Minimum Concrete Compressive Strength f'c ≥ 3,000 psi (20.7 MPa)			
		Ultimate Load		Allowable Load	
		Tension lbs. (kN)	Shear lbs. (kN)	Tension lbs. (kN)	Shear lbs. (kN)
1/4 (6.4)	2 (50.8)	3,320 (14.9)	2,720 (12.1)	830 (3.7)	680 (3.0)
3/8 (9.5)	1-1/2 (38.1)	2,220 (10.0)	2,200 (9.9)	555 (2.5)	550 (2.5)
	3 (76.2)	5,280 (23.8)	4,660 (20.7)	1,320 (5.9)	1,165 (5.1)
1/2 (12.7)	2 (50.8)	2,920 (13.1)	5,360 (23.6)	730 (3.3)	1,340 (5.9)
	4 (101.6)	7,720 (34.7)	9,260 (41.1)	1,930 (8.7)	2,315 (10.2)
5/8 (15.9)	2-1/2 (63.5)	3,720 (16.7)	9,240 (41.6)	930 (4.2)	2,310 (10.4)
	5 (127.0)	12,160 (54.7)	14,940 (66.4)	3,040 (13.7)	3,735 (16.6)
3/4 (19.1)	5-1/4 (133.4)	13,320 (59.9)	17,780 (79.0)	3,330 (15.0)	4,445 (19.7)

1. Tabulated load values are for anchors installed in structural sand-lightweight concrete. Concrete compressive strength must be at the specified minimum at the time of installation.
2. Allowable load capacities are calculated using an applied safety factor of 4.0.
3. Allowable load capacities are multiplied by reduction factors found in the Design Criteria section when anchor spacing or edge distances are less than critical distances.
4. Linear interpolation for allowable loads for anchors at intermediate embedment depths may also be used.

ASD PERFORMANCE DATA

Ultimate and Allowable Shear Load Capacities for Wedge-Bolt+ at 1-3/4" Edge of Normal-Weight Concrete^{1,2}

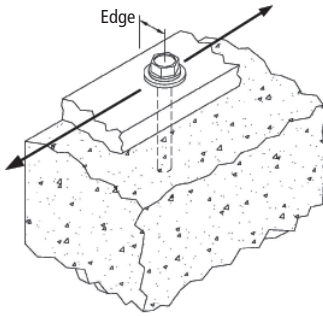

Nominal Anchor Diameter <i>d</i> in. (mm)	Minimum Embed. Depth <i>h_v</i> in. (mm)	Minimum Edge Distance <i>h_v</i> in. (mm)	<i>f</i> ' _c ≥ 2,000 psi (13.8 MPa)	
			Parallel to the Free Edge	
			Ultimate Shear lbs. (kN)	Allowable Shear lbs. (kN)
1/2 (12.7)	3-3/8 (85.7)	1-3/4 (44.5)	5,020 (22.6)	1,255 (5.6)
5/8 (15.9)	3-3/8 (85.7)	1-3/4 (44.5)	5,420 (24.4)	1,355 (6.1)
3/4 (19.1)	3-3/8 (85.7)	1-3/4 (44.5)	5,660 (25.5)	1,415 (6.4)

1. Tabulated load values are for anchors installed in concrete. Concrete compressive strength must be at the specified minimum at the time of installation.
2. Allowable load capacities are calculated using an applied safety factor of 4.0

Allowable Load Capacities for Wedge-Bolt+ Installed at 1-3/4" Edge of Normal-Weight Concrete Stem Walls^{1,2,3}

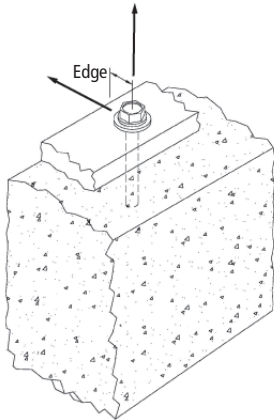

Nominal Anchor Diameter <i>d</i> in. (mm)	Minimum Embed. Depth <i>h_v</i> in. (mm)	Minimum Edge Distance <i>h_v</i> in. (mm)	<i>f</i> ' _c ≥ 2,500 psi (17.2 MPa)		
			Tension lbs. (kN)	Parallel to the Free Edge	Toward the Free Edge
				Shear lbs. (kN)	Shear lbs. (kN)
1/2 (12.7)	4 (101.6)	1-3/4 (44.5)	1,270 (5.67)	1,425 (6.4)	470 (2.1)
5/8 (15.9)	2 1/2 (63.5)	1-3/4 (44.5)	610 (2.7)	1,155 (5.2)	380 (1.7)
	3 3/4 (95.3)		1,310 (5.9)	1,330 (6.0)	490 (2.2)
	5 (127.0)		2,015 (9.1)	1,505 (6.8)	600 (2.7)

1. Tabulated load values are for anchors installed in concrete. Concrete compressive strength must be at the specified minimum at the time of installation.
2. Allowable load capacities are calculated using an applied safety factor of 4.0.
3. Allowable load capacities may also be applied to conditions at the edge of normal-weight concrete slabs.

MASONRY PERFORMANCE DATA

Allowable Load Capacities for Wedge-Bolt+ Anchors Installed into the Face of Grout Filled Concrete Masonry^{1,2,3,4,5}



MECHANICAL ANCHORS

Anchor Diameter d (in.) (mm)	Minimum Embed. h _v (in.) (mm)	Minimum Edge Distance (in.) (mm)	Minimum End Distance (in.) (mm)	Tension lbs. (kN)		Shear lbs. (kN)	
				f' m = 1,500 psi	f' m ≥ 2,000 psi	f' m = 1,500 psi	f' m ≥ 2,000 psi
1/4 (6.4)	1 (25.4)	3-3/4 (95.3)	3-3/4 (95.3)	80 (0.4)	80 (0.4)	150 (0.7)	150 (0.7)
	2 (50.8)	1-1/2 (38.1)	2-3/4 (69.9)	230 (1.0)	265 (1.2)	165 (0.7)	190 (0.8)
	2 (50.8)	3-3/4 (95.3)	3-3/4 (95.3)	340 (1.5)	340 (1.5)	340 (1.5)	340 (1.5)
3/8 (9.5)	1-1/2 (38.1)	3-3/4 (95.3)	12 (304.8)	210 (0.9)	210 (0.9)	400 (1.8)	400 (1.8)
	2-1/2 (63.5)	1-3/4 (44.5)	3-3/4 (95.3)	295 (1.3)	340 (1.5)	210 (0.9)	245 (1.1)
	2-1/2 (63.5)	7-7/8 (200.0)	12 (304.8)	750 (3.4)	750 (3.4)	655 (2.9)	655 (2.9)
	2-1/2 (63.5)	12 (304.8)		615 (2.7)	710 (3.1)	915 (4.0)	1055 (4.7)
	3-1/2 (88.9)	12 (304.8)		1,290 (5.8)	1,290 (5.8)	910 (4.0)	910 (4.0)
1/2 (12.7)	2 (50.8)	3-3/4 (95.3)	12 (304.8)	335 (1.5)	335 (1.5)	720 (3.2)	720 (3.2)
	3 (76.2)	7-7/8 (200.0)	3-3/4 (95.3)	930 (4.2)	930 (4.2)	900 (4.0)	900 (4.0)
	3-1/2 (88.9)	2-3/4 (69.9)		595 (2.6)	685 (3.0)	405 (1.8)	470 (2.1)
	4 (101.6)	12 (304.8)	12 (304.8)	1,525 (6.9)	1,525 (6.9)	1,085 (4.8)	1,085 (4.8)
5/8 (15.9)	2-1/2 (63.5)	3-3/4 (95.3)	12 (304.8)	455 (2.0)	455 (2.0)	1,085 (4.8)	1,085 (4.8)
	3-1/4	7-7/8 (200.0)		885 (4.0)	885 (4.0)	1,085 (4.8)	1,085 (4.8)
	4 (101.6)	12 (304.8)		1,310 (5.9)	1,310 (5.9)		
	5 (127.0)	12 (304.8)		1,940 (8.7)	1,940 (8.7)	1,255 (5.6)	1,255 (5.6)
3/4 (19.1)	3 (76.2)	3-3/4 (95.3)	12 (304.8)	615 (2.8)	615 (2.8)	750 (3.4)	750 (3.4)
		12 (304.8)		615 (2.8)	615 (2.8)	1,320 (5.9)	1,320 (5.9)
	3-1/2 (88.9)	7-7/8 (200.0)		1,035 (4.7)	1,035 (4.7)	1,265 (5.7)	1,265 (5.7)
	4 (101.6)	12 (304.8)		1,455 (6.5)	1,455 (6.5)	1,320 (5.9)	1,320 (5.9)
	5 (127.0)			1,680 (7.6)	1,680 (7.6)	1,775 (7.9)	1,775 (7.9)

1. Tabulated load values are for anchors installed in minimum 6" wide, Grade N, Type II, lightweight concrete masonry units conforming to ASTM C 90 that have reached the minimum designated ultimate compressive strength at the time of installation (f' m ≥ 1,500 psi).
2. Allowable load capacities listed are calculated using an applied safety factor of 5.0. Consideration of safety factors of 10 or higher may be necessary depending on the application, such as life safety.
3. Linear interpolation for allowable loads for anchors at intermediate embedment depths may be used.
4. Allowable shear loads for 1/4" and 3/8" diameter anchor installations into the face shell of a masonry wall may be applied in any direction. Allowable shear loads for anchor diameters 1/2" and greater installed into the face shell may be applied in any direction provided the location is a minimum of 12" from the edge of the wall. For anchor diameters 1/2" and greater installed with an edge distance less than 12" the allowable shear loads may be applied in any direction except upward vertically.
5. The tabulated load values are applicable for screw anchors installed at a minimum spacing between screw anchors of 16 times the screw anchor diameter.

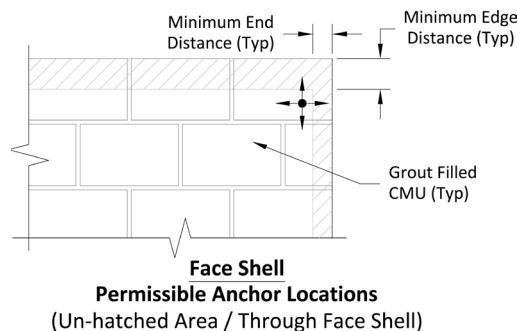

MASONRY PERFORMANCE DATA
Allowable Load Capacities for Wedge-Bolt+ Anchors Installed into the Top of Grout-Filled Concrete Masonry Wall^{1,2,3}

Nom. Anchor Diameter <i>d</i> in. (mm)	Min. Embed. Depth <i>h_v</i> in. (mm)	Minimum Edge Distance in. (mm)	Minimum End Distance in. (mm)	Tension lbs. (kN)		Shear (Toward Edge of Wall) lbs. (kN)		Shear (Toward End of Wall) lbs. (kN)	
				<i>f</i> ' _m = 1,500 psi	<i>f</i> ' _m ≥ 2,000 psi	<i>f</i> ' _m = 1,500 psi	<i>f</i> ' _m ≥ 2,000 psi	<i>f</i> ' _m = 1,500 psi	<i>f</i> ' _m ≥ 2,000 psi
3/8 (9.5)	2-1/2 (63.5)	1-1/2 (38.1)	3 (76.2)	310 (1.4)	355 (1.6)	140 (0.6)	160 (0.7)	250 (1.1)	290 (1.3)
	1-1/2 (38.1)	2 (50.8)	-	-	-	350 (1.6)	350 (1.6)	350 (1.6)	350 (1.6)
	2-1/2 (63.5)		-	570 (2.5)	570 (2.5)	380 (1.7)	380 (1.7)	380 (1.7)	380 (1.7)
1/2 (12.7)	3-1/2 (88.9)	1-3/4 (44.5)	3 (76.2)	535 (2.4)	620 (2.7)	260 (1.2)	305 (1.3)	240 (1.1)	275 (1.2)
	4-1/2 (114.3)	1-3/4 (44.5)	3 (76.2)	745 (3.3)	860 (3.8)	-	-	-	-
5/8 (15.9)	4-1/2 (114.3)	1-3/4 (44.5)	9 (228.6)	835 (3.7)	965 (4.3)	250 (1.1)	285 (1.2)	575 (2.6)	660 (2.9)
	5-1/2 (139.7)	2-3/4 (69.9)	9 (228.6)	1,005 (4.5)	1,165 (5.2)	420 (1.9)	490 (2.2)	-	-
	7-1/2 (190.5)	2-3/4 (69.9)	9 (228.6)	1,215 (5.4)	1,405 (6.2)	-	-	-	-

1. Tabulated load values are for carbon steel and stainless steel anchors installed in minimum 6-inch wide, minimum Grade N, Type II, lightweight, medium-weight or normal-weight concrete masonry units conforming to ASTM C 90. Mortar must be minimum Type N. Masonry compressive strength must be at the specified minimum at the time of installation.
2. Allowable load capacities listed are calculated using an applied safety factor of 5.0. Consideration of safety factors of 10 or higher may be necessary depending on the application, such as life safety.
3. The tabulated load values are applicable for screw anchors installed at a minimum spacing between screw anchors of 16 times the screw anchor diameter.

Allowable Load Capacities for Wedge-Bolt+ Anchors Installed into the T-Joint of Grout-Filled Concrete Masonry Wall^{1,2,3,4,5}

Nominal Anchor Diameter in. (mm)	Minimum Embed. Depth in. (mm)	Minimum Edge Distance in. (mm)	Minimum End Distance in. (mm)	Tension lbs. (kN)	Shear lbs. (kN)
3/8 (9.5)	1-1/2 (38.1)	16 (406.4)	16 (406.4)	-	510 (2.3)
	3-1/2 (88.9)			830 (3.7)	
1/2 (12.7)	4 (101.6)			1,090 (4.9)	
5/8 (15.9)	4 (101.6)			840 (3.8)	
3/4 (19.1)	2-1/2 (63.5)			-	1,225 (5.5)
	4 (101.6)	890 (4.0)			

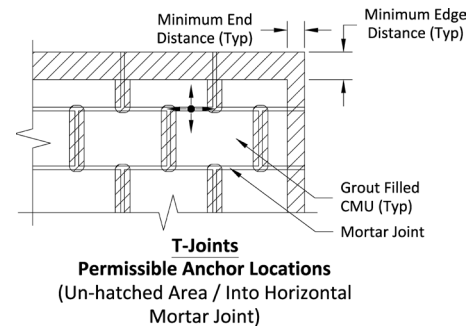

1. Tabulated load values are for carbon steel and stainless steel anchors installed in minimum 6-inch wide, minimum Grade N, Type II, lightweight, medium-weight or normal-weight concrete masonry units conforming to ASTM C 90. Mortar must be minimum Type N. Masonry compressive strength must be at the specified minimum at the time of installation (*f*'_m ≥ 1,500 psi).
2. Allowable load capacities listed are calculated using an applied safety factor of 5.0. Consideration of safety factors of 10 or higher may be necessary depending on the application, such as life safety.
3. Allowable shear loads for anchor installation into the horizontal and vertical mortar joints may be applied in any direction provided the anchor location is a minimum of 16" from the edge and end of the wall. For anchor installations with an edge distance less than 16" the allowable shear loads may be applied in any direction except upward vertically.
4. Linear interpolation for allowable loads for anchors at intermediate embedment depths may be used.
5. The tabulated load values are applicable for screw anchors installed at a minimum spacing between screw anchors of 16 times the screw anchor diameter.

MASONRY PERFORMANCE DATA

Allowable Load Capacities for Wedge-Bolt+ Anchors Installed into Multiple Wythe Solid Clay Brick Masonry^{1,2}

Nominal Anchor Dia. d in. (mm)	Minimum Embed. Depth hv in. (mm)	Minimum Edge & End Distance in. (mm)	Minimum Spacing Distance in	Tension lbs. (kN)	Shear lbs. (kN)
1/4 (6.4)	2-1/2 (63.5)	4 (101.6)	4" Any Direction	455 (2.0)	295 (1.3)
3/8 (9.5)	3-1/2 (88.9)	6 (152.4)	6" Any Direction	680 (3.1)	630 (2.8)
1/2 (12.7)	4 (101.6)	8 (203.2)	8" Any Direction	960 (4.3)	1,230 (5.5)
5/8 (15.9)	4 (101.6)	10 (254.0)	12" Any Direction	1,225 (5.5)	1,710 (7.6)
3/4 (19.1)	4 (101.6)	12 (304.8)	16" Any Direction	1,315 (5.9)	1,950 (8.7)

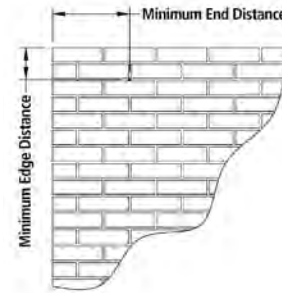

1. Tabulated load values are for anchors installed in multiple wythe, minimum Grade SW, solid clay brick masonry walls conforming to ASTM C 62. Mortar must be minimum Type N. Masonry compressive strength must be at the specified minimum at the time of installation ($f'm \geq 1,500$ psi).
2. Allowable load capacities listed are calculated using an applied safety factor of 5.0. Consideration of safety factors of 10 or higher may be necessary depending on the application, such as life safety.

DESIGN CRITERIA (ALLOWABLE STRESS DESIGN)

Combined Loading

For anchors loaded in both shear and tension, the combination of loads should be proportioned as follows:

$$\left(\frac{N_u}{N_n}\right)^{\frac{5}{3}} + \left(\frac{V_u}{V_n}\right)^{\frac{5}{3}} \leq 1 \quad \text{OR} \quad \left(\frac{N_u}{N_n}\right) + \left(\frac{V_u}{V_n}\right) \leq 1$$

Where: N_u = Applied Service Tension Load
 N_n = Allowable Tension Load
 V_u = Applied Service Shear Load
 V_n = Allowable Shear Load

Load Adjustment Factors for Spacing and Edge Distances¹

Anchor Installed in Normal-Weight Concrete					
Anchor Dimension	Load Type	Critical Distance (Full Anchor Capacity)	Critical Load Factor	Minimum Distance (Reduced Capacity)	Minimum Load Factor
Spacing (s)	Tension	$s_{cr} = 12d$	$FN_s = 1.0$	$s_{min} = 4d$	$FN_s = 0.50$
	Shear	$s_{cr} = 12d$	$FV_s = 1.0$	$s_{min} = 4d$	$FV_s = 0.75$
Edge Distnace (c)	Tension	$c_{cr} = 8d$	$FN_c = 1.0$	$c_{min} = 3d$	$FN_c = 0.70$
	Shear	$c_{cr} = 12d$	$FV_c = 1.0$	$c_{min} = 3d$	$FV_c = 0.15$

Anchor Installed in Structural Lightweight Concrete					
Anchor Dimension	Load Type	Critical Distance (Full Anchor Capacity)	Critical Load Factor	Minimum Distance (Reduced Capacity)	Minimum Load Factor
Spacing (s)	Tension	$s_{cr} = 14.1d$	$FN_s = 1.0$	$s_{min} = 4.7d$	$FN_s = 0.50$
	Shear	$s_{cr} = 14.1d$	$FV_s = 1.0$	$s_{min} = 4.7d$	$FV_s = 0.75$
Edge Distnace (c)	Tension	$c_{cr} = 9.4d$	$FN_c = 1.0$	$c_{min} = 3.5d$	$FN_c = 0.70$
	Shear	$c_{cr} = 14.1d$	$FV_c = 1.0$	$c_{min} = 3.5d$	$FV_c = 0.15$

1. Allowable load values found in the performance data tables are multiplied by reduction factors when anchor spacing or edge distances are less than critical distances. Linear interpolation is allowed for intermediate anchor spacing and edge distances between critical and minimum distances. When an anchor is affected by both reduced spacing and edge distance, the spacing and edge reduction factors must be combined (multiplied). Multiple reduction factors for anchor spacing and edge distance may be required depending on the anchor group configuration.

DESIGN CRITERIA (ALLOWABLE STRESS DESIGN)

Load Adjustment Factors for Normal-Weight Concrete

Spacing, Tension (F _{ts})						
Dia. (in.)	1/4	3/8	1/2	5/8	3/4	
S _{cr} (in.)	3	4-1/2	6	7-1/2	9	
S _{min} (in.)	1	1-1/2	2	2-1/2	3	
Spacing, s (inches)	1	0.50	-	-	-	-
	1-1/2	0.63	0.50	-	-	-
	2	0.75	0.58	0.50	-	-
	2-1/2	0.88	0.67	0.56	0.50	-
	3	1.00	0.75	0.63	0.55	0.50
	4-1/2	-	1.00	0.81	0.70	0.63
	6	-	-	1.00	0.85	0.75
	7-1/2	-	-	-	1.00	0.88
	9	-	-	-	-	1.00

Notes: For anchors loaded in tension, the critical spacing (S_{cr}) is equal to 12 anchor diameters (12d) at which the anchor achieves 100% of load.

Minimum spacing (S_{min}) is equal to 4 anchor diameters (4d) at which the anchor achieves 50% of load.

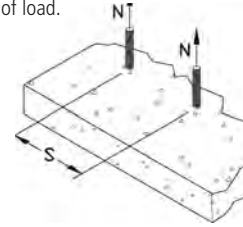

Spacing, Shear (F _{vs})						
Dia. (in.)	1/4	3/8	1/2	5/8	3/4	
S _{cr} (in.)	3	4-1/2	6	7-1/2	9	
S _{min} (in.)	1	1-1/2	2	2-1/2	3	
Spacing, s (inches)	1	0.75	-	-	-	-
	1-1/2	0.81	0.75	-	-	-
	2	0.88	0.79	0.75	-	-
	2-1/2	0.91	0.83	0.78	0.75	-
	3	1.00	0.88	0.81	0.78	0.75
	4-1/2	-	1.00	0.91	0.85	0.81
	6	-	-	1.00	0.93	0.88
	7-1/2	-	-	-	1.00	0.94
	9	-	-	-	-	1.00

Notes: For anchors loaded in shear, the critical spacing (S_{cr}) is equal to 12 anchor diameters (12d) at which the anchor achieves 100% of load.

Minimum spacing (S_{min}) is equal to 4 anchor diameters (4d) at which the anchor achieves 75% of load.

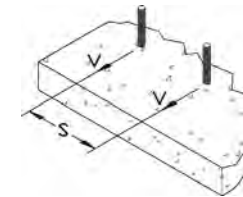

Edge Distance, Tension (F _{tc})						
Dia. (in.)	1/4	3/8	1/2	5/8	3/4	
C _{cr} (in.)	2	3	4	5	6	
C _{min} (in.)	3/4	1-1/8	1-1/2	1-7/8	2-1/4	
Edge Distance, c (in.)	3/4	0.70	-	-	-	-
	1-1/8	0.79	0.70	-	-	-
	1-1/2	0.88	0.76	0.70	-	-
	1-7/8	0.97	0.82	0.75	0.70	-
	2	1.00	0.84	0.76	0.71	-
	2-1/4	-	0.88	0.79	0.74	0.70
	3	-	1.00	0.88	0.81	0.76
	4	-	-	1.00	0.90	0.84
	5	-	-	-	1.00	0.92
6	-	-	-	-	1.00	

Notes: For anchors loaded in tension, the critical edge distance (C_{cr}) is equal to 8 anchor diameters (8d) at which the anchor achieves 100% of load.

Minimum edge distance (C_{min}) is equal to 3 anchor diameters (3d) at which the anchor achieves 70% of load.

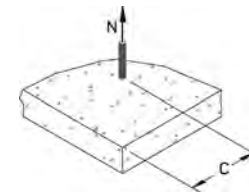

Edge Distance, Shear (F _{vc})						
Dia. (in.)	1/4	3/8	1/2	5/8	3/4	
C _{cr} (in.)	3	4-1/2	6	7-1/2	9	
C _{min} (in.)	3/4	1-1/8	1-1/2	1-7/8	2-1/4	
Edge Distance, c (in.)	3/4	0.15	-	-	-	-
	1-1/8	0.29	0.15	-	-	-
	1-1/2	0.43	0.24	0.15	-	-
	1-7/8	0.58	0.34	0.22	0.15	-
	2-1/4	0.72	0.43	0.29	0.21	0.15
	3	1.00	0.62	0.43	0.32	0.24
	4-1/2	-	1.00	0.72	0.55	0.43
	6	-	-	1.00	0.77	0.62
	7-1/2	-	-	-	1.00	0.81
9	-	-	-	-	1.00	

Notes: For anchors loaded in shear, the critical edge distance (C_{cr}) is equal to 12 anchor diameters (12d) at which the anchor achieves 100% of load.

Minimum edge distance (C_{min}) is equal to 3 anchor diameters (3d) at which the anchor achieves 15% of load.

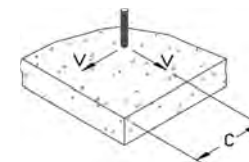

DESIGN CRITERIA (ALLOWABLE STRESS DESIGN)

Load Adjustment Factors for Structural Lightweight Concrete

Spacing, Tension (F _{Ns})					
Dia. (in.)	1/4	3/8	1/2	5/8	3/4
S _{cr} (in.)	3-1/2	5-1/4	7	8-7/8	10-1/2
S _{min} (in.)	1-1/4	1-3/4	2-3/8	3	3-1/2
Spacing, s (inches)	1-1/4	0.50	-	-	-
	1-3/4	0.61	0.50	-	-
	2-3/8	0.75	0.59	0.50	-
	3	0.89	0.67	0.57	0.50
	3-1/2	1.00	0.74	0.62	0.54
	5-1/4	-	1.00	0.82	0.74
	7	-	-	1.00	0.84
	8-7/8	-	-	-	1.00
	10-1/2	-	-	-	-
	10-1/2	-	-	-	-

Notes: For anchors loaded in tension, the critical spacing (s_{cr}) is equal to 14.1 anchor diameters (14.1d) at which the anchor achieves 100% of load. Minimum spacing (s_{min}) is equal to 4.7 anchor diameters (4.7d) at which the anchor achieves 50% of load.

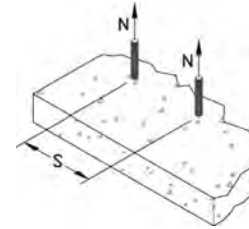

Spacing, Shear (F _{vs})					
Dia. (in.)	1/4	3/8	1/2	5/8	3/4
S _{cr} (in.)	3-1/2	5-1/4	7	8-7/8	10-1/2
S _{min} (in.)	1-1/4	1-3/4	2-3/8	3	3-1/2
Spacing, s (inches)	1-1/4	0.75	-	-	-
	1-3/4	0.81	0.75	-	-
	2-3/8	0.88	0.79	0.75	-
	3	0.94	0.84	0.78	0.75
	3-1/2	1.00	0.87	0.81	0.77
	5-1/4	-	1.00	0.91	0.85
	7	-	-	1.00	0.92
	8-7/8	-	-	-	1.00
	10-1/2	-	-	-	-
	10-1/2	-	-	-	-

Notes: For anchors loaded in shear, the critical spacing (s_{cr}) is equal to 14.1 anchor diameters (14.1d) at which the anchor achieves 100% of load. Minimum spacing (s_{min}) is equal to 4.7 anchor diameters (4.7d) at which the anchor achieves 75% of load.

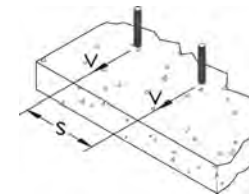

Edge Distance, Tension (F _{Nc})					
Dia. (in.)	1/4	3/8	1/2	5/8	3/4
C _{cr} (in.)	2-3/8	3-1/2	4-3/4	5-7/8	7
C _{min} (in.)	7/8	1-3/8	1-3/4	2-1/4	2-5/8
Edge Distance, c (in.)	7/8	0.70	-	-	-
	1-3/8	0.80	0.70	-	-
	1-3/4	0.88	0.76	0.70	-
	2-1/4	0.88	0.83	0.75	0.70
	2-3/8	0.98	0.84	0.76	0.72
	2-5/8	1.00	0.88	0.79	0.74
	3-1/2	-	1.00	0.88	0.81
	4-3/4	-	-	1.00	0.91
	5-7/8	-	-	-	1.00
	7	-	-	-	-

Notes: For anchors loaded in tension, the critical edge distance (c_{cr}) is equal to 9.4 anchor diameters (9.4d) at which the anchor achieves 100% of load. Minimum edge distance (c_{min}) is equal to 3.5 anchor diameters (3.5d) at which the anchor achieves 70% of load.

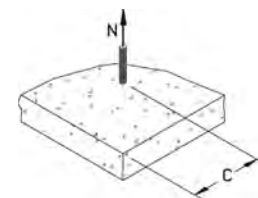

Edge Distance, Shear (F _{Vc})					
Dia. (in.)	1/4	3/8	1/2	5/8	3/4
C _{cr} (in.)	3-1/2	5-1/4	7	8-7/8	10-1/2
C _{min} (in.)	7/8	1-3/8	1-3/4	2-1/4	2-5/8
Edge Distance, c (in.)	7/8	0.15	-	-	-
	1-3/8	0.31	0.15	-	-
	1-3/4	0.43	0.24	0.15	-
	2-1/4	0.59	0.35	0.23	0.15
	2-5/8	1.00	0.43	0.29	0.21
	3-1/2	-	0.62	0.43	0.32
	5-1/4	-	1.00	0.71	0.54
	7	-	-	1.00	0.77
	8-7/8	-	-	-	1.00
	10-1/2	-	-	-	-

Notes: For anchors loaded in shear, the critical edge distance (c_{cr}) is equal to 14.1 anchor diameters (14.1d) at which the anchor achieves 100% of load.

Minimum edge distance (c_{min}) is equal to 3.5 anchor diameters (3.5d) at which the anchor achieves 15% of load

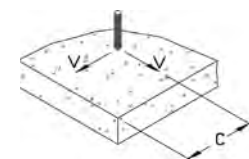

SD PERFORMANCE DATA
Tension Design Information (For use with load combinations taken from ACI 318 Section 9.2)^{1,2,3}

Design Characteristic	Notation	Units	Nominal Anchor Size						
			1/4"	3/8"	1/2"	5/8"	3/4"		
Anchor category	1, 2 or 3	-	1	1	1	1	1	1	
Nominal embedment depth	h_{nom}	in.	1-3/4	2-1/8	2-1/2	3-1/2	3-1/4	4-3/8	4-1/4
STEEL STRENGTH IN TENSION⁴									
Minimum specified ultimate strength	f_{uta}	ksi (N/mm ²)	100.0 (690)	100.0 (690)	100.0 (690)	100.0 (690)	100.0 (690)	100.0 (690)	100.0 (690)
Effective tensile stress area	A_{se}	in ² (mm ²)	0.044 (28.4)	0.103 (66.5)	0.168 (108.4)	0.168 (108.4)	0.249 (160.6)	0.249 (160.6)	0.371 (239.4)
Steel strength in tension	N_{sa}	lb (kN)	4,400 (19.6)	10,300 (45.8)	16,800 (74.7)	16,800 (74.7)	24,900 (110.7)	24,900 (110.7)	37,100 (164.9)
Reduction factor for steel strength ³	ϕ	-	0.65						
CONCRETE BREAKOUT STRENGTH IN TENSION⁵									
Effective embedment	h_{ef}	in. (mm)	1.100 (28)	1.425 (36)	1.650 (42)	2.500 (64)	2.145 (54)	3.100 (79)	2.910 (74)
Effectiveness factor for uncracked concrete	k_{uncr}	-	24	24	24	24	24	24	24
Effectiveness factor for cracked concrete	k_{cr}	-	-	17	17	17	17	17	17
Modification factor for cracked and uncracked concrete ⁵	$\Psi_{c,N}$	-	1.0 See note 5	1.0 See note 5	1.0 See note 5	1.0 See note 5	1.0 See note 5	1.0 See note 5	1.0 See note 5
Critical edge distance	c_{ac}	in. (mm)	2-1/2 (64)	2-3/4 (70)	4 (102)	4-1/2 (114)	5 (127)	5 (127)	6 (152)
Reduction factor for concrete breakout strength ³	ϕ	-	Condition B = 0.65						
PULLOUT STRENGTH IN TENSION (NON-SEISMIC APPLICATIONS)⁶									
Characteristic pullout strength, uncracked concrete (2,500 psi) ⁶	$N_{p,uncr}$	lb (kN)	See note 7	See note 7	See note 7	See note 7	See note 7	See note 7	See note 7
Characteristic pullout strength, cracked concrete (2,500 psi) ⁶	$N_{p,cr}$	lb (kN)	N/A	See note 7	See note 7	2,965 (13.2)	3,085 (13.7)	4,290 (19.1)	See note 7
Reduction factor for pullout strength ³	ϕ	-	Condition B = 0.65						
PULLOUT STRENGTH IN TENSION FOR SEISMIC APPLICATIONS⁹									
Characteristic pullout strength, seismic ^{6,9}	N_{eq}	lb (kN)	N/A	1,085 (4.8)	1,350 (6.0)	2,520 (11.2)	3,085 (13.7)	4,290 (19.1)	4,270 (19.0)
Reduction factor for pullout strength ³	ϕ	-	Condition B = 0.65						
PULLOUT STRENGTH IN TENSION FOR STRUCTURAL SAND-LIGHTWEIGHT AND NORMAL-WEIGHT CONCRETE OVER STEEL DECK									
Characteristic pullout strength, uncracked concrete over steel deck ¹⁰	$N_{p,deck,uncr}$	lb (kN)	N/A	2,010 (8.9)	2,480 (11.0)	3,760 (16.7)	4,095 (18.2)	4,095 (18.2)	N/A
Characteristic pullout strength, cracked concrete over steel deck ¹⁰	$N_{p,deck,cr}$	lb (kN)	N/A	1,425 (6.3)	1,755 (7.8)	3,045 (13.5)	2,665 (11.9)	2,665 (11.9)	N/A
Reduction factor for pullout strength ³	ϕ	-	Condition B = 0.65						

- The data in this table is intended to be used with the design provisions of ACI 318 Appendix D; for anchors resisting seismic load combinations the additional requirements of Section D.3.3 shall apply.
- Installation must comply with published instructions and details.
- All values of ϕ were determined from the load combinations of ACI 318 Section 9.2. If the load combinations of Appendix C are used, the appropriate value of ϕ must be determined in accordance with ACI 318 Section D.4.5. For reinforcement that meets ACI 318 Appendix D requirements for Condition A, see ACI 318 Section D.4.4 for the appropriate ϕ factor.
- The Wedge-Bolt+ is considered a brittle steel element as defined by ACI 318 Section D.1.
- For all design cases use $\Psi_{c,N} = 1.0$. Select appropriate effectiveness factor for cracked concrete (k_{cr}) or uncracked concrete (k_{uncr}).
- For all design cases use $\Psi_{c,N} = 1.0$. For concrete compressive strength greater than 2,500 psi, $N_{pn} = (\text{pullout strength value from table}) \times (\text{specified concrete compressive strength}/2500)^{0.5}$.
- Pullout strength will not control design of indicated anchors. Do not calculate pullout strength for indicated anchor size and embedment.
- Reported values for characteristic pullout strength in tension for seismic applications are based on test results per ACI 355.2, Section 9.5.
- Anchors are permitted to be used in structural sand-lightweight concrete provided that N_b and N_{pn} are multiplied by a factor of 0.60 (not required for steel deck).
- Values for $N_{p,deck}$ are for structural sand-lightweight concrete ($f'_{c,min} = 3,000$ psi) and additional lightweight concrete reduction factors need not be applied. In addition, evaluation for the concrete breakout capacity in accordance with ACI 318 Section D.5.2 is not required for anchors installed in the flute (soffit).

SD PERFORMANCE DATA

Shear Design Information (For use with load combinations taken from ACI 318 Section 9.2)^{1,2,3}

Design Characteristic	Notation	Units	Nominal Anchor Size						
			1/4"	3/8	1/2"	5/8	3/4"		
Anchor category	1, 2 or 3	-	1	1	1	1	1	1	
Nominal embedment depth	h_{nom}	in.	1-3/4	2-1/8	2-1/2	3-1/2	3-1/4	4-3/8	4-1/4
STEEL STRENGTH IN SHEAR⁴									
Minimum specified ultimate strength	V_{sa}	lb (kN)	2,475 (11.0)	4,825 (21.5)	7,980 (35.5)	11,990 (53.3)	19,350 (86.1)		
Reduction factor for steel strength ³	ϕ	-	0.60						
CONCRETE BREAKOUT STRENGTH IN SHEAR⁶									
Effective embedment	ℓ_e	in. (mm)	1.100 (28)	1.425 (36)	1.650 (42)	2.500 (64)	2.145 (54)	3.100 (79)	2.910 (74)
Nominal anchor diameter	d_a	in. (mm)	0.250 (6.4)	0.375 (9.5)	0.500 (12.7)	0.625 (15.9)	0.750 (19.1)		
Reduction factor for concrete breakout strength ³	ϕ	-	Condition B = 0.70						
PRYOUT STRENGTH IN SHEAR⁶									
Characteristic pullout strength, uncracked concrete (2,500 psi) ⁶	k_{cp}	-	1.0	1.0	1.0	2.0	1.0	2.0	2.0
Characteristic pullout strength, cracked concrete (2,500 psi) ⁶	h_{ef}	in. (mm)	1.100 (28)	1.425 (36)	1.650 (42)	2.500 (64)	2.145 (54)	3.100 (79)	2.910 (74)
Reduction factor for pullout strength ³	ϕ	-	Condition B = 0.70						
STEEL STRENGTH IN SHEAR FOR SEISMIC APPLICATIONS⁷									
Characteristic pullout strength, seismic ^{6,9}	V_{eq}^{10}	lb (kN)	N/A	3,670 (16.3)	7,980 (35.5)	11,990 (53.3)	12,970 (57.7)		
Reduction factor for pullout strength ³	ϕ	-	Condition B = 0.60						
STEEL STRENGTH IN SHEAR FOR STRUCTURAL SAND-LIGHTWEIGHT AND NORMAL-WEIGHT CONCRETE OVER STEEL DECK⁹									
Characteristic pullout strength, uncracked concrete over steel deck ¹⁰	$V_{sa,deck}$	lb (kN)	N/A	1,640 (7.3)	3,090 (13.7)	3,140 (14.0)	3,305 (14.7)	N/A	
Reduction factor for pullout strength ³	ϕ	-	Condition B = 0.60						

- The data in this table is intended to be used with the design provisions of ACI 318 Appendix D; for anchors resisting seismic load combinations the additional requirements of Section D.3.3 shall apply.
- Installation must comply with published instructions and details.
- All values of ϕ were determined from the load combinations of ACI 318 Section 9.2. If the load combinations of Appendix C are used, the appropriate value of ϕ must be determined in accordance with ACI 318 Section D.4.5. For reinforcement that meets ACI 318 Appendix D requirements for Condition A, see ACI 318 Section D.4.4 for the appropriate ϕ factor.
- The Wedge-Bolt+ is considered a brittle steel element as defined by ACI 318 Section D.1.
- Reported values for steel strength in shear are based on test results per ACI 355.2, Section 9.4 and shall be used for design. These reported values may be lower than calculated results using Equation D-20 in ACI 318-05 Section D.6.1.2 and D-18 in ACI 318-02, Section D.6.1.2.
- Anchors are permitted to be used in structural sand-lightweight concrete provided that V_b and V_{cp} are multiplied by a factor of 0.60 (not required for steel deck).
- Reported values for steel strength in shear for seismic applications are based on test results per ACI 355.2, Section 9.6.
- Values for $V_{sa,deck}$ are for structural sand-lightweight concrete ($f'_{c,min} = 3,000$ psi) and additional lightweight concrete reduction factors need not be applied. In addition, evaluation for the concrete breakout capacity in accordance with ACI 318 Section D.6.2 and the pryout capacity in accordance with Section D.6.3 are not required for anchors installed in the flute (soffit).
- Shear loads for anchors installed through steel deck into concrete may be applied in any direction.
- For 2003 IBC code basis, replace V_{sa} with V_s ; and ℓ_e with ℓ and V_{eq} with $V_{sa,seis}$.

ORDERING INFORMATION



**Wedge-Bolt+ Screw Anchor
(Carbon Steel Body With Blue Tip)**

Cat. No.	Anchor Size	Box Qty.	Ctn. Qty.	Wt./100 (lbs)
7204SD	1/4" x 1-1/4"	100	600	3
7206SD	1/4" x 1-3/4"	100	600	4
7208SD	1/4" x 2-1/4"	100	600	4
7210SD	1/4" x 3"	100	500	5
7220SD	3/8" x 1-3/4"	50	300	9
7222SD	3/8" x 2-1/2"	50	300	10
7224SD	3/8" x 3"	50	250	12
7226SD	3/8" x 4"	50	250	15
7228SD	3/8" x 5"	50	250	18
7230SD	3/8" x 6"	50	150	22
7240SD	1/2" x 2"	50	200	15
7242SD	1/2" x 2-1/2"	50	200	17
7244SD	1/2" x 3"	50	150	20
7246SD	1/2" x 4"	50	150	26
7248SD	1/2" x 5"	25	100	30
7250SD	1/2" x 6"	25	75	35
7268SD	1/2" x 6-1/2"	25	75	37
7252SD	1/2" x 8"	25	75	43
7260SD	5/8" x 3"	25	100	35
7262SD	5/8" x 4"	25	100	41
7264SD	5/8" x 5"	25	75	48
7266SD	5/8" x 6"	25	75	54
7270SD	5/8" x 8"	25	75	65
7280SD	3/4" x 3"	20	60	50
7282SD	3/4" x 4"	20	60	60
7284SD	3/4" x 5"	20	60	71
7286SD	3/4" x 6"	20	60	81
7288SD	3/4" x 8"	10	40	103
7290SD	3/4" x 10"	10	30	100

Shaded catalog numbers denote sizes which are less than the minimum standard anchor length for Strength Design.
The published size includes the diameter and length of the anchor measured from under the head.
Wedge-Bolt+ is marked with a blue tip and must be installed with a matched tolerance Wedge-Bit.



**Wedge-Bolt+ Screw Anchor
(Mechanically Galvanized)**

Cat. No.	Anchor Size	Box Qty.	Ctn. Qty.
7726SD	3/8" x 4"	50	250
7728SD	3/8" x 5"	50	250
7730SD	3/8" x 6"	50	150
7746SD	1/2" x 4"	50	150
7748SD	1/2" x 5"	25	100
7750SD	1/2" x 6"	25	75
7751SD	1/2" x 6-1/2"	25	75
7752SD	1/2" x 8"	25	75
7764SD	5/8" x 5"	25	75
7766SD	5/8" x 6"	25	75
7768SD	5/8" x 6-1/2"	25	75
7770SD	5/8" x 8"	25	75
7786SD	3/4" x 6"	20	60
7789SD	3/4" x 8-1/2"	10	40
7790SD	3/4" x 10"	10	20

The published size includes the diameter and length of the anchor measured from under the head.
Wedge-Bolt+ is marked with a blue tip and must be installed with a matched tolerance Wedge-Bit.

ORDERING INFORMATION



Wedge-Bit

Cat. No.	Wedge-Bit Description	Usable Length	Tube Qty.	Ctn. Qty.
01312	SDS 1/4" x 4"	2"	1	250
01314	SDS 1/4" x 6"	4"	1	100
01316	SDS 3/8" x 6"	4"	1	200
01318	SDS 3/8" x 8"	6"	1	100
01332	SDS 3/8" x 12"	10"	1	50
01319	SDS 3/8" x 18"	16"	1	50
01320	SDS 1/2" x 6"	4"	1	150
01322	SDS 1/2" x 10"	8"	1	50
01334	SDS 1/2" x 12"	10"	1	50
01335	SDS 1/2" x 18"	16"	1	50
01324	SDS 5/8" x 8"	6"	1	75
01326	SDS 5/8" x 12"	10"	1	75
01336	SDS 5/8" x 18"	16"	1	50
01328	SDS 3/4" x 8"	6"	1	100
01330	SDS 3/4" x 12"	10"	1	50
01340	Spline 1/2" x 13"	8"	1	20
01342	Spline 1/2" x 16"	11"	1	-
01344	Spline 5/8" x 13"	8"	1	20
01348	Spline 3/4" x 13"	8"	1	20
01354	SDS-Max 1/2" x 13"	8"	1	20
01356	SDS-Max 5/8" x 13"	8"	1	20
01358	SDS-Max 3/4" x 13"	8"	1	20
01370	HD Straight Shank 1/4" x 4"	3"	1	100
01372	HD Straight Shank 1/4" x 6"	2-1/2"	1	-
01380	HD Straight Shank 3/8" x 6"	4"	1	-
01384	HD Straight Shank 3/8" x 13"	4"	1	-
01390	HD Straight Shank 1/2" x 6"	11"	1	-
01394	HD Straight Shank 1/2" x 13"	11"	1	50
01396	HD Straight Shank 5/8" x 13"	11"	1	-
01397	HD Straight Shank 3/4" x 13"	11"	1	-

**Wedge-Bolt+ Screw Anchor
Installation Accessories**

Cat. No.	Description	Wt./100 (lbs)
08280	Hand pump / dust blower	1



MECHANICAL ANCHORS